

CAELearningSpace

ONE Box System Setup Guide



CAE

Copyright © CAE Healthcare Academy, 2023. All rights reserved. No part of this document may be reproduced without written consent from CAE Healthcare Academy.

CAE Healthcare
6300 Edgelake Dr
Sarasota, FL 34240
USA
Tel +941-377-5562
caehealthcare.com

Dear Valued Customer,

Congratulations, and thank you for your recent purchase of the CAE LearningSpace ONE Box system. This guide will help you get started using CAE LearningSpace. In addition, a CAE LearningSpace user guide is available from within the CAE LearningSpace web software.

The CAE LearningSpace ONE Box system includes the following components:

- CAE LearningSpace software (web-based)
- ONE Box unit

If you have any questions or comments, please email CAE LearningSpace Customer Service in North America at **avs-support@cae.com** (phone 1-866-462-7920).

International Customer Service information is available at **<https://caehealthcare.com/contact-us/>**

NOTE: When contacting customer service, please have the serial number and ID available. They are located on the ID sticker placed on the back of the ONE Box, as shown on page 5.

CAELearningSpace

ONE Box System Setup Guide

Welcome to CAE LearningSpace!

The present guide helps you get started using CAE LearningSpace – intelligent recording, easy debriefing. It explains how to get your system started.

1.0 Equipment Setup	5
2.0 Initial Network Setup	8
3.0 Licensing	10
4.0 Initial System Setup	12
5.0 Attaching Unit(s) to the Connect Server	14
6.0 Connecting simulators	16
6.1 Connecting CAE simulators wirelessly	16
6.2 Connecting CAE simulators using a wired connection	17
6.3 Connecting third-party (non-CAE) simulators	17

1.0 Equipment Setup

Upon receiving your CAE LearningSpace system, unpack and set up the equipment.

If more than one piece of equipment was ordered, unpack, and set up all parts.

To unpack and set up the equipment:

1.1 Remove the ONE Box from the package.



Power button

The front of CAE LearningSpace ONE Box

ID sticker of
your unit

Capped-off
power input port



Power port

Back ports of the Box

1.2 Attach the two antennas to the back of the ONE Box (screw them on).



Back of the Box

- 1.3 To power your ONE Box: First, plug the adapter to the power port of the unit. Only afterward plug the other end of the adapter into your power source.

NOTE: There is a capped-off power input port on the motherboard, that MUST not be used.



Power port of the ONE Box

- 1.4 Connect your institution network cable (Ethernet cable) to the ONE Box Network port 1 (LAN).*

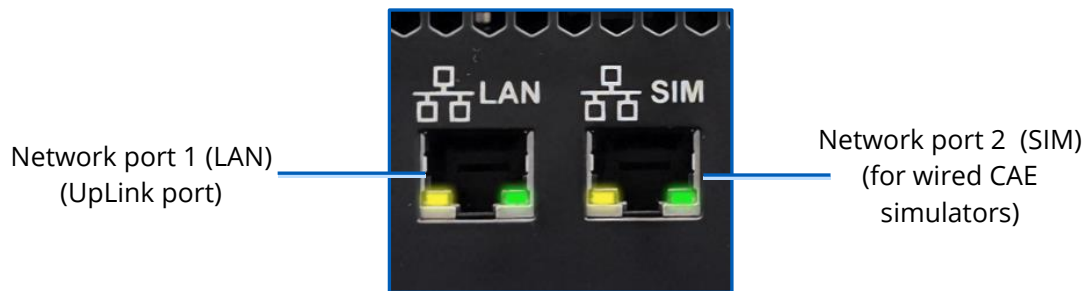

Box network ports

- 1.5 Connect your client computer to a ONE Box AV network port (with an Ethernet cable).

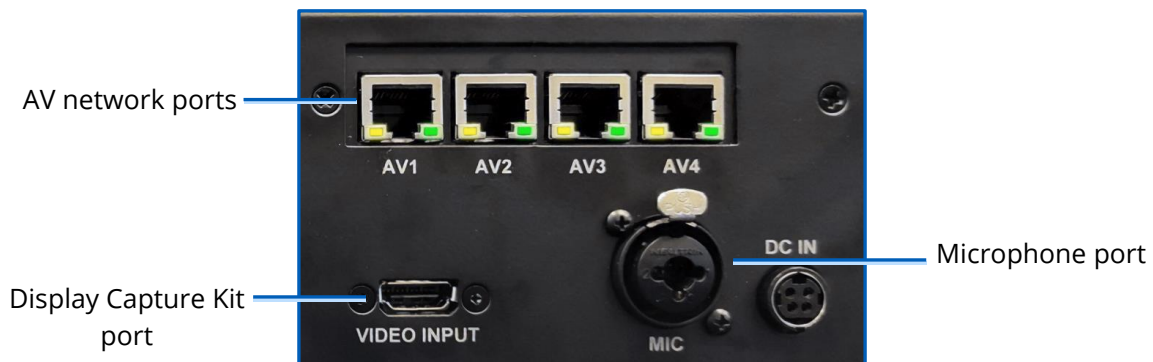

Ports of the Box

* If you are unsure, please consult your local IT.

- 1.6 Secure all cameras at your location.
- 1.7 Connect each camera to a ONE Box AV network port (with Ethernet cable).
For further instructions, refer to the online manual of your camera(s); search by their model number.
- 1.8 Connect the Display Capture Kit cable to the Box and its other end to the monitor display you want to capture.
- 1.9 Connect the Microphone to the Box.

If applicable, connect your wired CAE simulator to Network port 2 (SIM) (with an Ethernet cable).

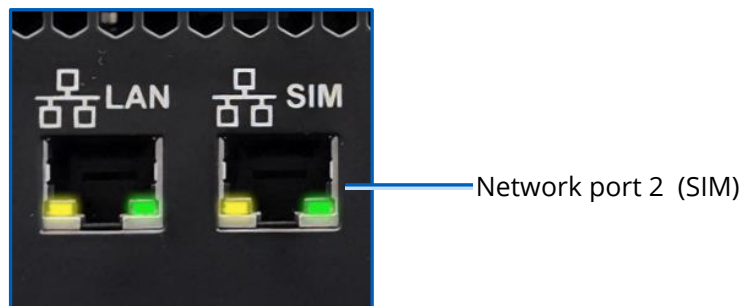

Box network ports

- 1.10 Power on the ONE Box (the power button is on the front of the Box).

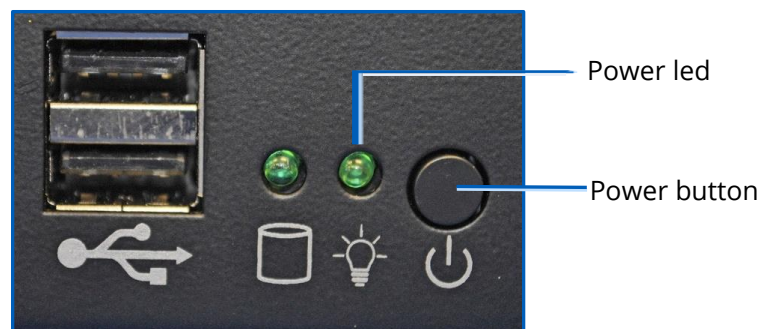

Front of the Box

IMPORTANT: The ONE Box unit must be powered off before unplugging it from a power source to avoid data loss.

NOTE: To power off the unit (proper shutdown), push the power button briefly - it is not necessary to keep the button pushed longer than a keystroke – and wait until the power led turns off.

2.0 Initial Network Setup

To set up your ONE Box's network connection and set up your initial login:

- 2.1 Ensure your client computer is connected to a ONE Box AV network port (with an Ethernet cable).

IMPORTANT: Make sure that this is the only network connection on your client computer, and the wired interface is set to DHCP.

- 2.2 Open your browser and enter the address: ***http://setup.learning.space***

The CAE LearningSpace initial setup screen appears.

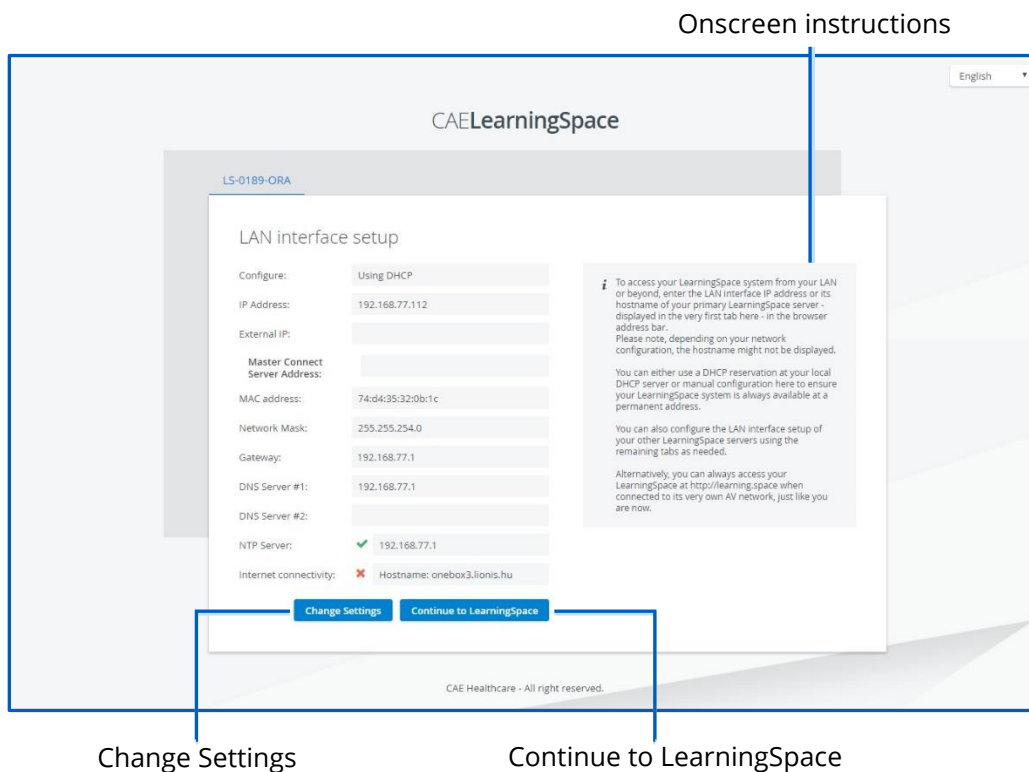

CAE LearningSpace Initial Setup screen

- 2.3 Follow the onscreen instructions. For changing the LAN interface settings, click **Change Settings** at the bottom of the window.

All settings become editable:

Configure: Using DHCP Manually

IP Address:* 192.168.77.112

External IP:

Master Connect Server Address:

MAC address: 74:d4:35:32:0b:1c

Network Mask:* 255.255.254.0

Gateway:* 192.168.77.1

DNS Server #1: 192.168.77.1

DNS Server #2:

NTP Server:* 192.168.77.1

Save Settings Cancel

i To access your LearningSpace system from your LAN or beyond, enter the LAN interface IP address or its hostname of your primary LearningSpace server - displayed in the very first tab here - in the browser address bar. Please note, depending on your network configuration, the hostname might not be displayed.

You can either use a DHCP reservation at your local DHCP server or manual configuration here to ensure your LearningSpace system is always available at a permanent address.

You can also configure the LAN interface setup of your other LearningSpace servers using the remaining tabs as needed.

Alternatively, you can always access your LearningSpace at <http://learning.space> when connected to its very own AV network, just like you are now.

Initial Setup Screen with editable settings

IMPORTANT: All fields marked with an asterisk (*) are required.

2.4 When you have finished editing, click **Save Settings**.

2.5 Once you are done with the settings, click **Continue to LearningSpace** or enter **learning.space** in the browser.

NOTE: In case the license of the software was already activated (see 3.0), the **Continue to LearningSpace** button or the **learning.space** URL directs you to the **Initial Settings** tab (see 4.3 in 4.0), where you are required to provide the Admin login credentials (password and email) and the location.

INITIAL SETTINGS

Language: English

Date format: MM/DD/YYYY

Time format: hh:mm:ss am/pm

First day of week: Sunday

Location region: Select area

Location city: Select city

Admin password:

Admin email:

Save & Continue

In this way, you skip logging in with the default email address and password (see 4.2). If you need to activate the license, continue to 3.0, then 4.0. After license activation, use the default email address and password provided by the guide for the first login.

3.0 Licensing

Following the network setup, the purchased CAE LearningSpace software can be activated online (3.2.1) by connecting to the Internet or offline (3.2.2) – if the internet connection was not detected successfully – by contacting the CAE support team.

IMPORTANT: During the activation process, the computer cannot be shut down.

- 3.1 The **Continue to LearningSpace** button or **learning.space** leads you to the licensing page (unless the licensing has been already concluded – see p. 9).

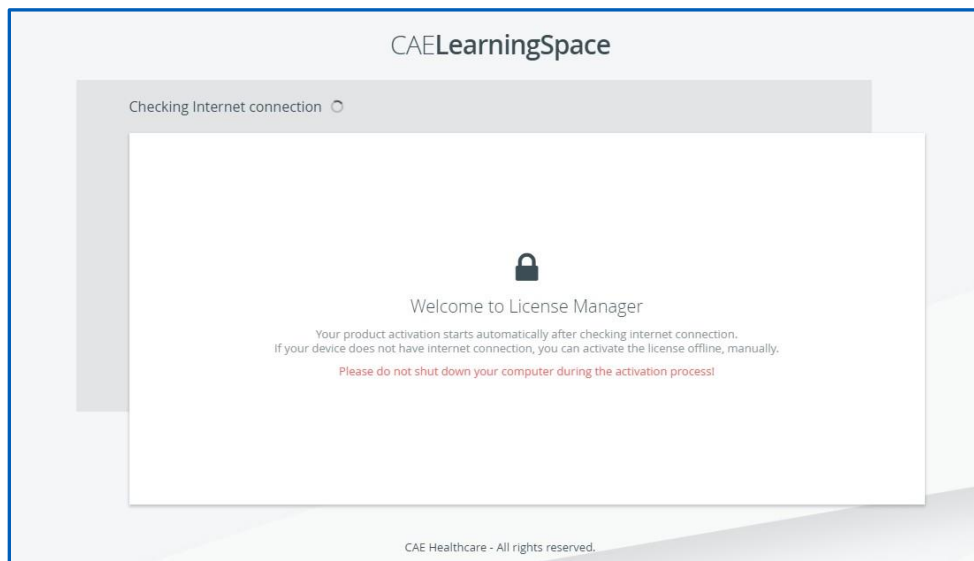

Detecting internet connection on the licensing page

- 3.2 The system checks for internet connection.

Click the **Start Activation** button on the licensing page to proceed.

3.2.1 Online activation

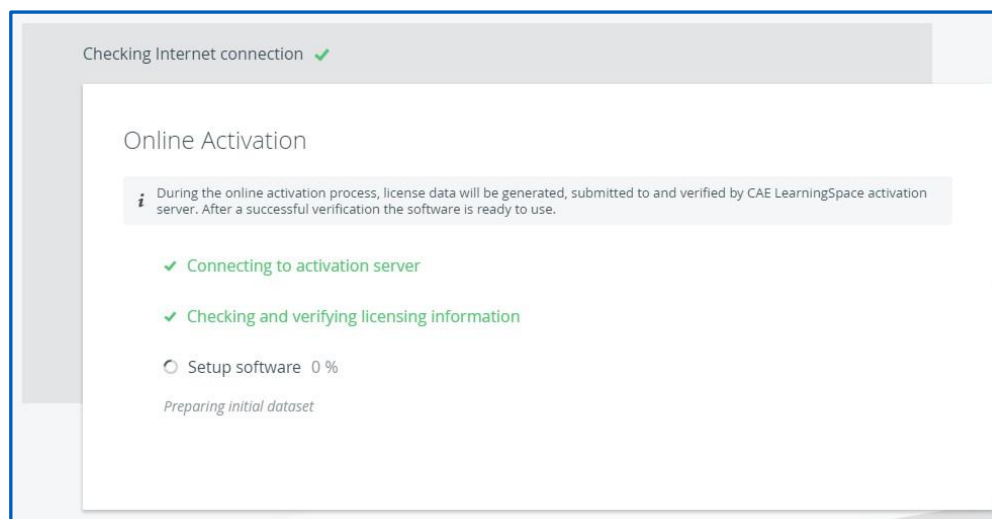

Online licensing page

The license verification runs automatically, and once completed, a system message is displayed with a green **Login** button to proceed to the login page.

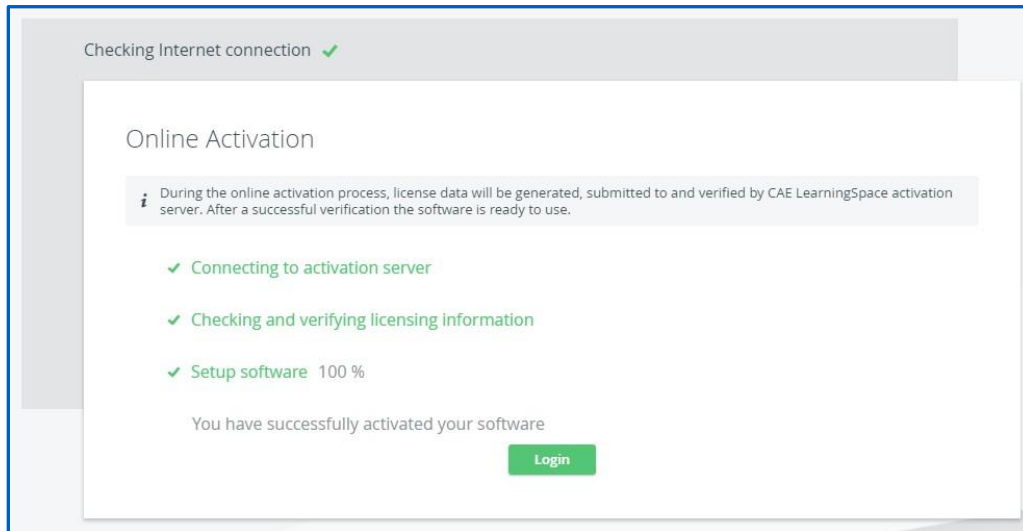

Completed online licensing

3.2.2 Offline activation

IMPORTANT: Please have the serial number ready to identify your unit. You can find the ID sticker with the number of your unit on the back of the ONE Box (as on p. 5).

Call CAE LearningSpace support to receive your Activation Code.

Enter the activation code in the designated field on the offline licensing page.

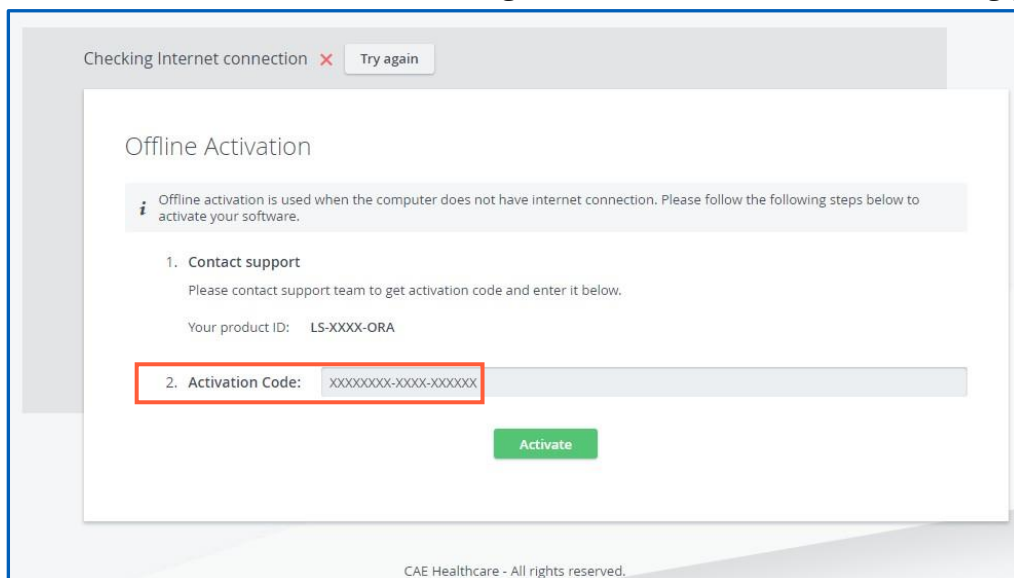

Offline licensing page

Click **Activate** once you are finished.

4.0 Initial System Setup

Once the licensing is successfully concluded, the **Login** button is displayed.

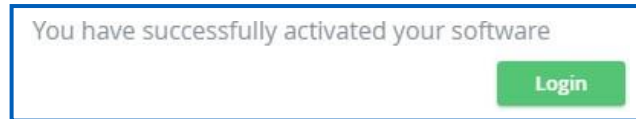

Activation success message and login button

4.1 Click **Login**, and you will land on the login page:

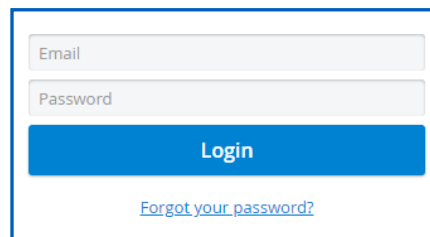
A screenshot of a login form with a blue border. It contains two input fields: "Email" and "Password". Below these fields is a blue button with the text "Login". At the bottom of the form, there is a blue hyperlink that says "Forgot your password?".

LearningSpace login fields

4.2 Logging in for the first time, enter the default email address and password:

email: admin@learning.space

password: mls#changeme

You will be redirected to the **Initial Settings** tab.

4.3 Change the default email address and password on the first login. Admin password, email, and location fields are required before continuing.

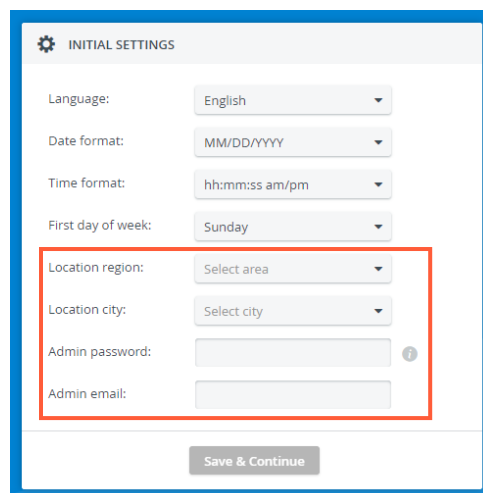
A screenshot of the "INITIAL SETTINGS" page. The page has a blue border and a gear icon in the top left corner. It contains several settings: "Language:" with a dropdown menu set to "English"; "Date format:" with a dropdown menu set to "MM/DD/YYYY"; "Time format:" with a dropdown menu set to "hh:mm:ss am/pm"; "First day of week:" with a dropdown menu set to "Sunday"; "Location region:" with a dropdown menu set to "Select area"; "Location city:" with a dropdown menu set to "Select city"; "Admin password:" with a text input field and an information icon; and "Admin email:" with a text input field. A red box highlights the "Location region:", "Location city:", "Admin password:", and "Admin email:" fields. At the bottom of the page, there is a "Save & Continue" button.

NOTE: Passwords have to meet a minimum requirement to ensure the security of your user accounts. The new password has to be 8 characters or longer and has to include at least one of each of the following characters: lower case letters, upper case letters, numbers, and special characters/symbols.

You can change other settings (e.g., language, time format, etc.) with the help of drop-down menus (optional).

When all required fields are filled, the **Save & Continue** button becomes active.

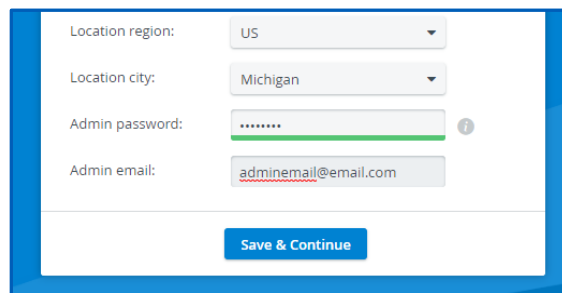

The screenshot shows a form with the following fields:

- Location region: US (dropdown menu)
- Location city: Michigan (dropdown menu)
- Admin password: (password field with a strength indicator and an information icon)
- Admin email: adminemail@email.com (text field)

At the bottom of the form is a blue button labeled "Save & Continue".

4.4 Clicking **Save & Continue**, and the system redirects you to its home page.

For further information on the software, please find the help site of the product you are using at <https://help.caelearningspace.com>

5.0 Attaching Unit(s) to the Connect Server

If you have more than one unit and wish to incorporate them in a single CAE LearningSpace system, CAE LearningSpace Connect Server provides the solution. You can integrate CAE LearningSpace ONE Boxes into one CAE LearningSpace system with the help of the CAE LearningSpace Connect Server.

WARNING: If a CAE LearningSpace ONE Box was already used as a stand-alone unit, all data stored on the unit will become inaccessible* upon configuring and integrating it into the CAE LearningSpace Connect Server.

To configure your CAE LearningSpace ONE Box as a unit of the CAE LearningSpace Connect Server:

- 5.1 Ensure your client computer is connected to a ONE Box AV network port (with an Ethernet cable).

IMPORTANT: Make sure this is the only network connection on your client computer, and the wired interface is set to DHCP.

- 5.2 Open your browser and enter the address: **<http://setup.learning.space>**
The CAE LearningSpace initial setup screen appears.

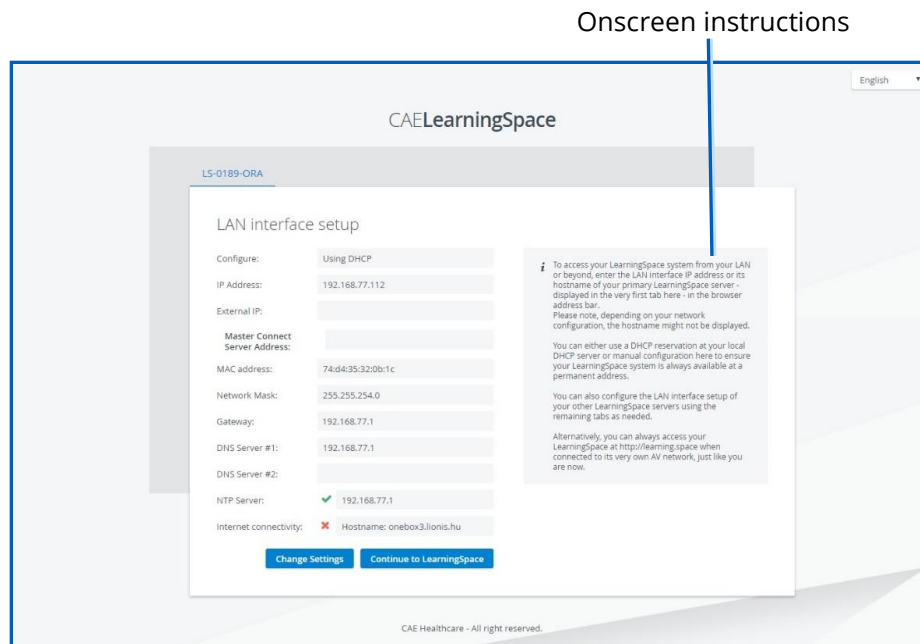

Initial Setup Screen of a new unit ready for integration

* Data stored on the stand-alone unit will not be deleted following the configuration, only hidden while the unit is connected to a CAE LearningSpace Connect Server. You can retrieve your data when you reconfigure your ONE Box once again as a stand-alone unit.

5.3 Click the **Change Settings** button at the bottom of the window. All settings become editable.

Configure: Using DHCP Manually

IP Address:* 192.168.77.112

External IP:

Master Connect Server Address: connectserver

MAC address: 74:d4:35:32:0b:1c

Network Mask:* 255.255.254.0

Gateway:* 192.168.77.1

DNS Server #1: 192.168.77.1

DNS Server #2:

NTP Server:* 192.168.77.1

[Save Settings](#) [Cancel](#)

i To access your LearningSpace system from your LAN or beyond, enter the LAN interface IP address or its hostname of your primary LearningSpace server - displayed in the very first tab here - in the browser address bar. Please note, depending on your network configuration, the hostname might not be displayed. You can either use a DHCP reservation at your local DHCP server or manual configuration here to ensure your LearningSpace system is always available at a permanent address. You can also configure the LAN interface setup of your other LearningSpace servers using the remaining tabs as needed. Alternatively, you can always access your LearningSpace at <http://learning.space> when connected to its very own AV network, just like you are now.

Editable Initial Setup screen

5.4 Type the address of your Connect Server into the **Master Connect Server Address** field.

NOTE: IP address and domain name can also be used as alternatives.

5.5 Click **Save Settings** to establish connection with the master server.

5.6 Click **Continue to LearningSpace**.

A prompt message confirms that the unit has been successfully assigned to your **LearningSpace Connect Server**.

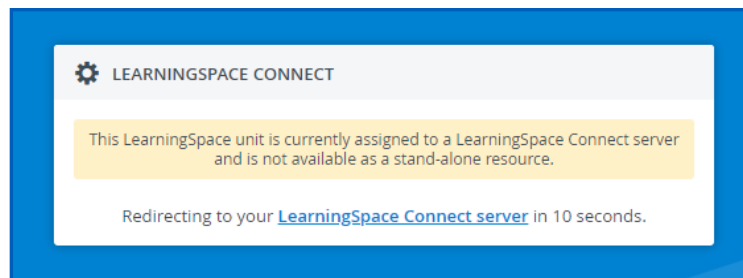

LearningSpace Connect confirmation message

NOTE: If your client computer is connected to the ONE Box AV network port, disconnect it, and reset your initial network connection to the institution network.

6.0 Connecting simulators

After the initial setups are completed: equipment, network, licensing, and system setup, you can continue with connecting your simulators to your system.

Every CAE LearningSpace system can capture simulator signals of any kind.

The setup guide distinguishes between the following types of simulators:

- CAE simulators with wireless connection
- CAE simulators with a wired connection
- Third-party (non-CAE) simulators

6.1 Connecting CAE simulators wirelessly

In case of using wireless CAE simulators, do the following:

- 6.1.1 First, CAE LearningSpace has to establish a wireless connection to the CAE simulator, to do this:
- 6.1.2 In **System** → **Simulators**, select the **Controls** cogwheel on the left side and select the wireless network of the simulator.

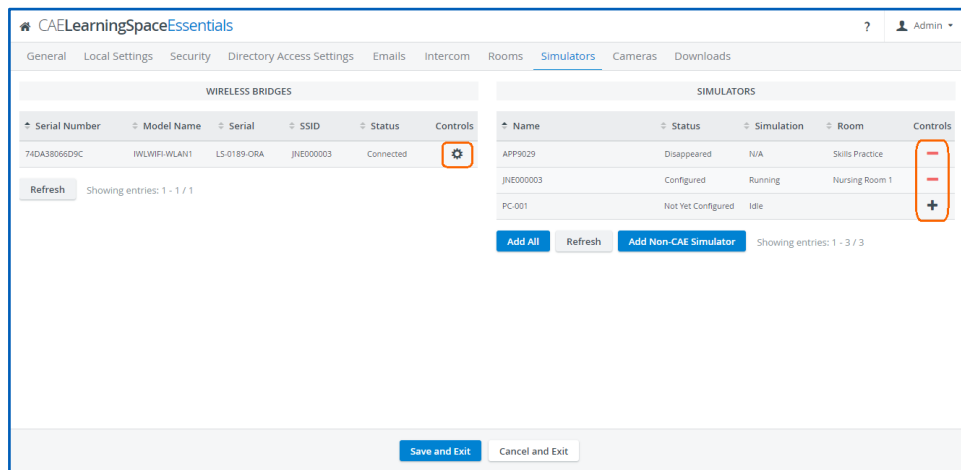

- a. In case there are no Wireless Bridges listed on the left side panel, make sure that the two antennas are screwed to the back of the Box.



Back ports of the Box

- b. In case the CAE simulator is not listed when trying to connect to the WiFi network:
 - i. Make sure the simulator is powered on.
 - ii. Move the ONE Box closer to the simulator.
- 6.1.3 Connect to the selected CAE simulator.
- 6.1.4 The CAE simulator will show up within 10-30 seconds on the right-side panel.
- 6.1.5 After adding the simulator using the + icon, you can add the simulator to the desired room, using the **Rooms** tab.

6.2 Connecting CAE simulators using a wired connection

In case of using CAE simulators with a wired connection, do the following:

- 6.2.1 Connect your simulator to Network port 2 (SIM) with an Ethernet cable.

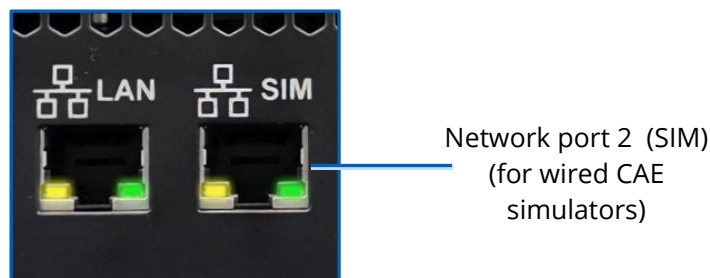

Box network ports

- 6.2.2 Make sure the simulator is turned ON.
- 6.2.3 Check for the simulator in the **Simulators** panel in **System** → **Simulators** if it is listed. (It will appear in 10-30 seconds.)
- 6.2.4 Click the desired icon in the **Controls** column to add or remove the simulator.
- 6.2.5 To add the simulator to the desired room, use the **Rooms** tab.

6.3 Connecting third-party (non-CAE) simulators

Third-party (non-CAE) simulator signals are captured using display capture technology. In the case of CAE ONE Box, the display capture capability is built-in.

In case of using third-party simulators, do the following:

- 6.3.1 Check the video output of the waveform display of the third-party simulator; it can be DVI, HDMI.

6.3.2 Select the appropriate video cable (and adapter) you need for connecting the simulator to the frame grabber:

NOTE: The CAE ONE Box has a HDMI input.

- For capturing signals from non-CAE simulator with DVI output: use the **DVI to HDMI adapter cable** included (DVI cable not included).
- For capturing signals from non-CAE simulators with HDMI output: use a **HDMI cable** (not included).

6.3.3 Run the appropriate video cable to the input of the ONE appliance and the output of the simulator and connect them.

6.3.4 You need to locate the DCU on the **Cameras** tab and add it to a room on the **Rooms** tab.

CAE LearningSpace

caehealthcare.com

For more information about CAE Healthcare products, contact your regional sales manager or the CAE Healthcare distributor in your country or visit caehealthcare.com. Tel +1 941-377-5562 or 866-233-6384

For customer service, please contact CAE Healthcare.

United States

Monday - Friday
from 7:00 a.m. to 6:00 p.m.
ET Phone 1-866-462-7920

Canada

Monday - Friday
from 8:00 a.m. to 5:00 p.m.
ET Phone 1-877-223-6273

International

Monday - Friday
from 7:00 a.m. to 6:00 p.m.
ET Phone + 1-514-341-6780



LearningSpace Customer Service by Email

avs-support@cae.com

©2023 CAE Healthcare